



EURO VISTA FOLD™

THERMALLY BROKEN ALUMINUM FOLDING DOORS



Florida Building Code Approved
Product Approval FL 27023

www.euro-wall.com
888.989.EURO (3876)

euro-wall®

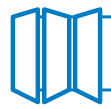

FOLDING

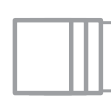

SLIDING



STACKING

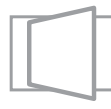

PIVOT

SYSTEM THRESHOLDS

Maximum / Minimum Specifications

Max Panel Weight:	350 lbs each panel
Min Panel Width:	18"
Max Panel Width:	52"
Min Panel Height:	32"
Max Panel Height:	144"
Panel Thickness:	2-1/4"
Max # of Panels:	Unlimited

NOTE: When using maximum panel widths & heights, panels may exceed maximum panel weight of 350 lbs. Calculated weight check should be done. For installations in Florida, please see the Florida Product Approval for usage and limitations.

SYSTEM HIGHLIGHTS

Extrusions

Extruded aluminum 6063-T5 with door panel corner keys for strength and security

Hardware

Stainless steel (316/304SS) components with aluminum hinges

Twinpoint Hardware

Stainless steel (304SS) and aluminum components

Lever Lock Sets

3 hooks + top & bottom shootbolts = 5 point locking system

Multi-point Door Locks

Faceplate, latch and hooks are 304SS

Sills

Standard, modified standard, ADA and channel options

Matching Fixed Units

Matching custom transom and sidelight units available

Thermally Broken

Prevent the conductive thermal energy loss from interior and exterior environments

Configuration

Straight, segmented or radius

Corner Units

90° postless corner units

Largest Panel Sizes

12' tall panel heights / 52" panel widths available - the largest in the industry

Long Lasting Finish

Standard finish coating is AAMA 2605, the highest quality finish available

Aesthetics

Custom muntins, simulated divided lites and mid-rails



SYSTEM COMPONENTS

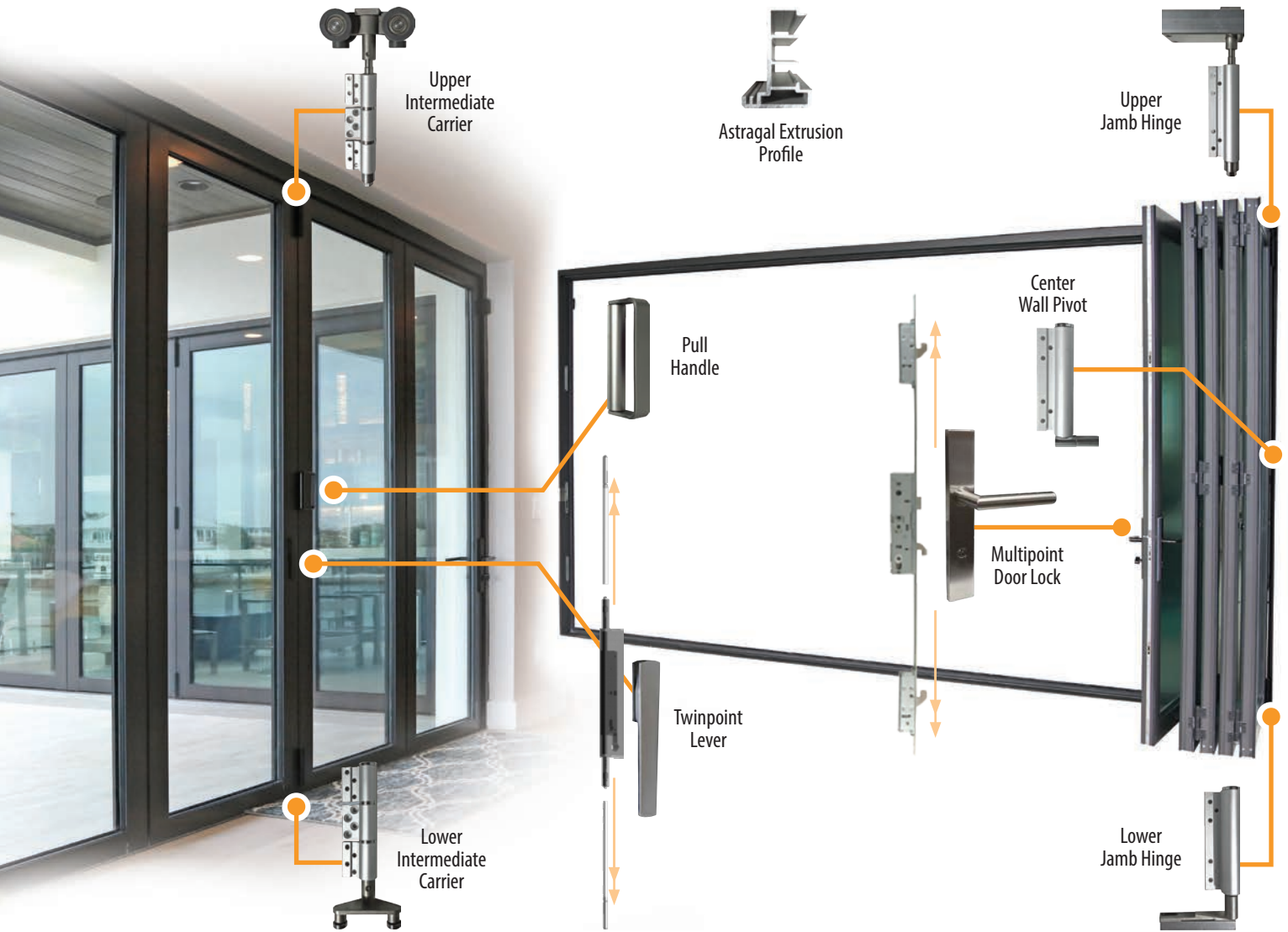

SILL OPTIONS

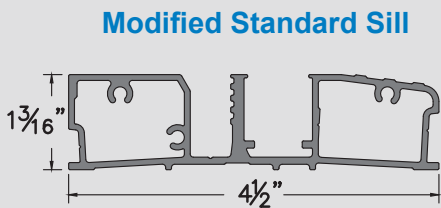
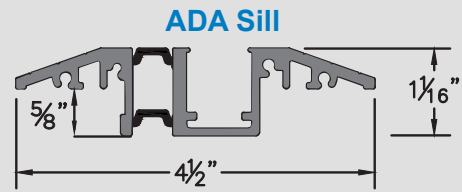
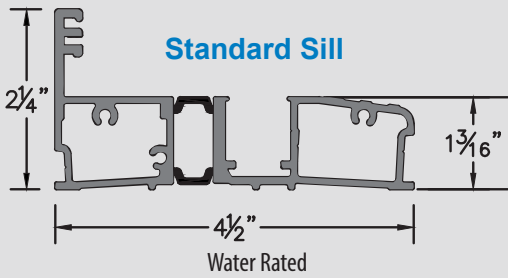

Channel Sill
Interior Application Only

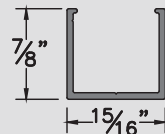

PANEL FINISH OPTIONS

STANDARD FRAME & DOOR PANEL FINISHES

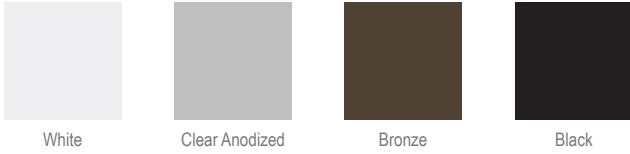

White

Clear Anodized

Bronze

Black

STANDARD FRAME & DOOR PANEL FINISHES

- Powder coat or Kynar® finishes available
- Custom powder coat or Kynar® finishes available
- Manufacturer color match options
- Custom wood grain finishes available

INTERIOR WOOD CLAD FINISH OPTION

- Mahogany / sapele
- White oak
- Additional wood species available



HARDWARE / HANDLE FINISH OPTIONS

MULTIPOINT LOCK HANDLE



Available Finishes

- Polished Stainless Steel**
- Brushed Satin**
- Bronze**
- Black**

TWINPOINT LEVER



Available Finishes

- White**
- Brushed Satin**
- Bronze**
- Black**

Custom Colors Available

HINGES / HARDWARE



Available Finishes

- White**
- Brushed Satin**
- Bronze**
- Black**

NOTE: The colors shown in this brochure give only an approximation of color and finish. Actual colors and finishes may vary.

SUPERIOR BY DESIGN

FOLDING CONFIGURATIONS

CODE		OPENING CONFIGURATION		
2L		Accessible from interior only. Exterior available upon request.	2R	
2L1R			1L2R	
3L			3R	
3L1R			1L3R	
4L		Accessible from interior only. Exterior available upon request.	2L2R	
4L1R				
3L2R				
5L				
3L3R				
7L				
4L3R				
5L2R				
5L5R				
5L7R				
5L9R				
5L11R				

NOTE: The configurations on this page are just a few examples of the numerous possibilities for Euro Vista Fold™ Door layout options.

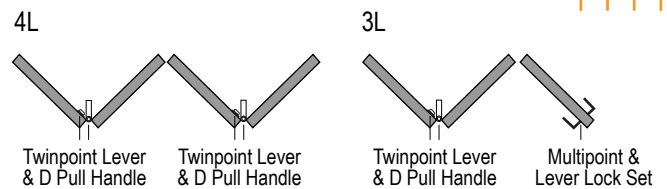

Twinpoint assembly is used in securing each pair of folding door panels in the closed position.

PANEL CROSS SECTION
Outswing Extrusion Shown

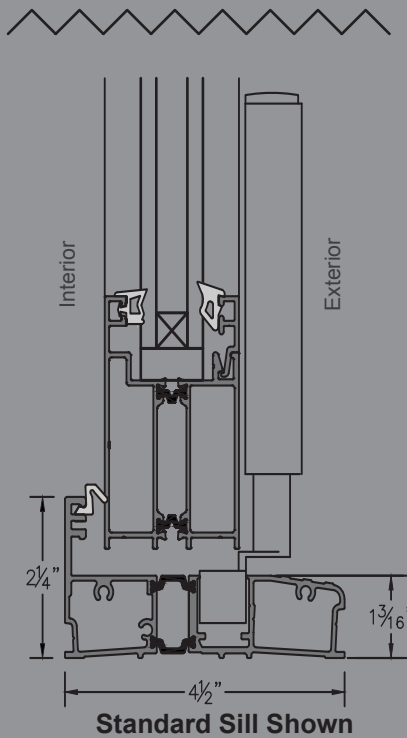
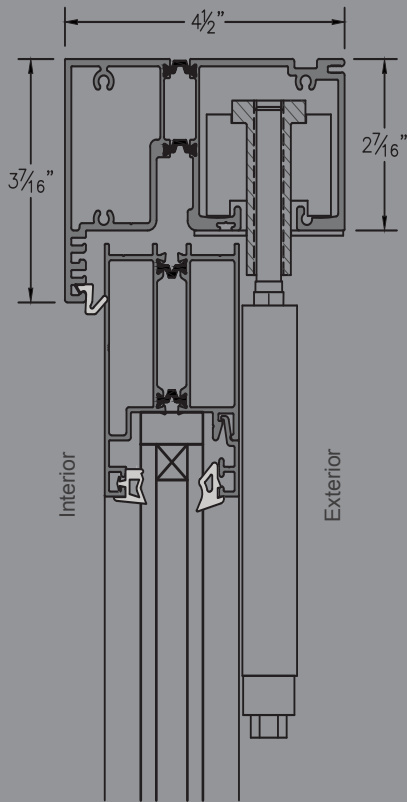

Standard Sill Shown

GLAZING DETAILS

Available glass options for the Euro Vista Fold™ Thermally Broken Folding Door System are detailed below.

Insulated Impact Glass

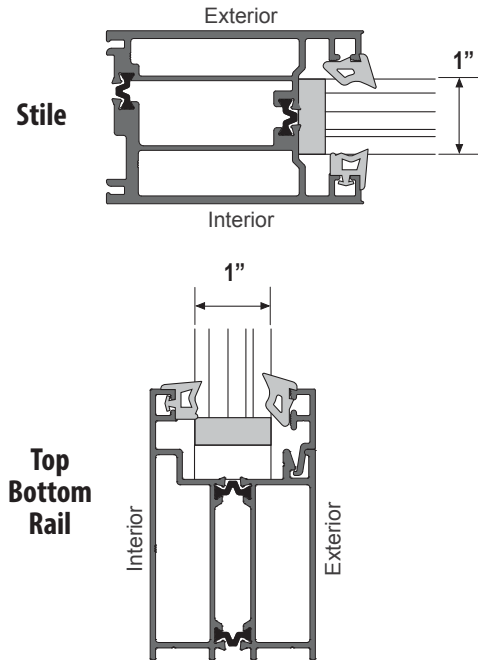

Insulated Glass

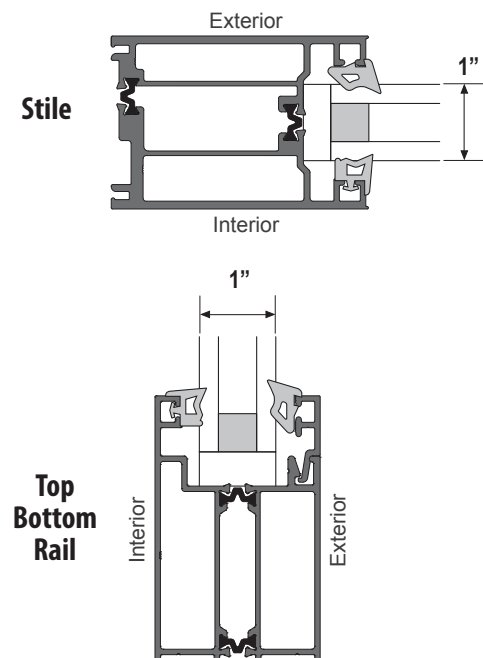

TEST PERFORMANCES

—□ California Title 24 Compliant

—□ ASTM 283-4 / ASTM 547-00 /
ASTM330-02 / AAMA 1304

—□ Air Infiltration: A2

—□ Water Leakage Resistance: DP50

—□ Wind Load Resistance: DP50

—□ Tested for Thermal Requirements

CONFIGURATION SAMPLES

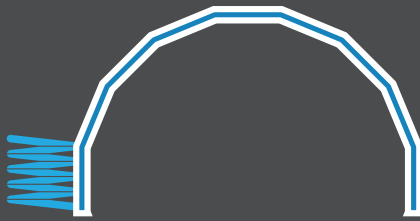

RADIUS

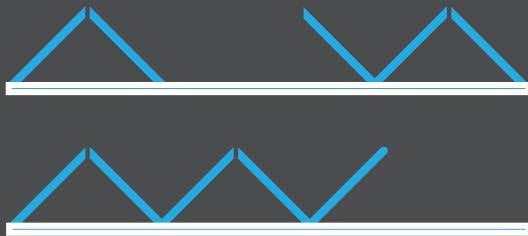
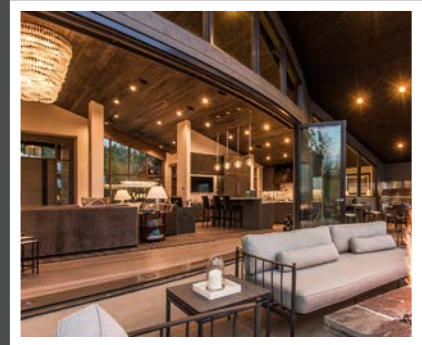

STRAIGHT

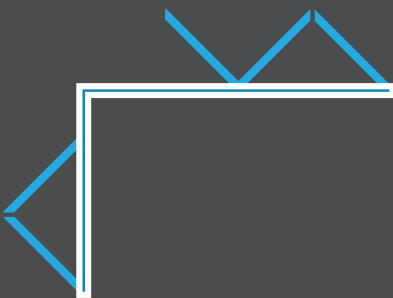

SEGMENTED





EURO-WALL 10 YEAR WARRANTY

Euro-Wall warrants the products to be free from manufacturing defects for a period of 10 years from the date of purchase.

MANUFACTURING

2200 Murphy Court
North Port, Florida 34289
888.989.3876 • 941.979.5316

888.989.EURO (3876)
www.euro-wall.com

euro-wall®

FOLDING | SLIDING | STACKING | PIVOT

SHOWROOM

1211 Stirling Road, Unit 102,
Dania Beach, Florida 33004
954.610.2572

Proud Member of the American Architectural Manufacturers Association.

