



RAYDOOR[®]
Sliding Walls & Doors

WHY RAYDOOR

BEAUTY, FLEXIBILITY & PRIVACY

Raydoor designs and manufactures elegant and innovative interior dividing solutions.

Our products are a result of over 20 years dedicated to pursuing and improving the art and technology of interior division. What began as a flexible solution for privacy in open-plan living soon addressed markets as diverse as hospitality, retail and commercial office space.

Our highly-customizable products and knowledgeable team provide our customers with a unique and beautiful method of dividing any space while maintaining light. Between our broad offering and inventive approach to operable partitions, we have evolved our line-up into a set of products that have few comparables in the marketplace.





WHAT MAKES RAYDOOR UNIQUE

Our patented twin-frame panel design is constructed by “sandwiching” two frames on either side of one of a variety of inserts. The result is a rigid and lightweight panel that is durable and easy to operate.

We combine this with our high-quality hardware to offer systems that can be configured to work in many ways. Aesthetically enhancing a space while adding flexibility and maintaining light are the 3 key aims of the Raydoor product line.

With our nearly endless options for customization and our patented hardware that requires no floor track, a Raydoor system can blend seamlessly into a space or make a bold statement.

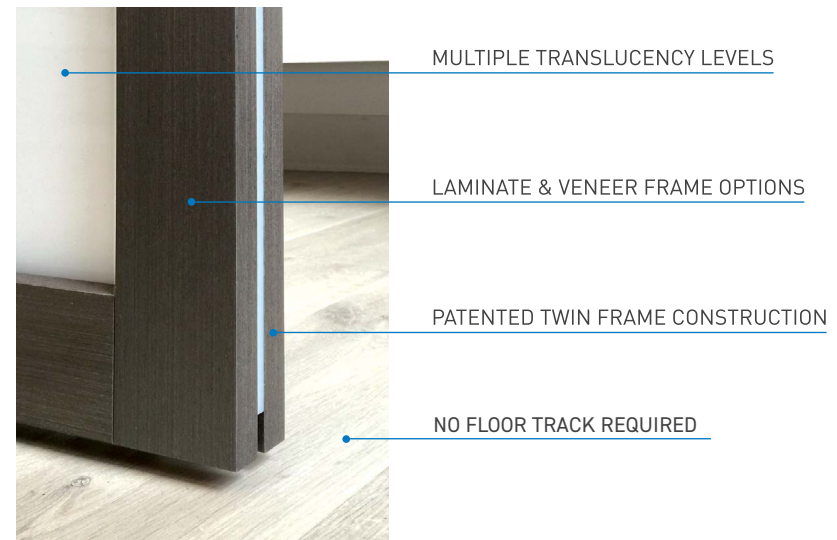



TRANSFORM SPACE

SOLUTIONS

Transforming spaces both functionally and aesthetically can be done in numerous ways with a Raydoor system. The range of solutions we provide can address something as simple as a residential closet opening or as grand as a luxury hotel lobby.

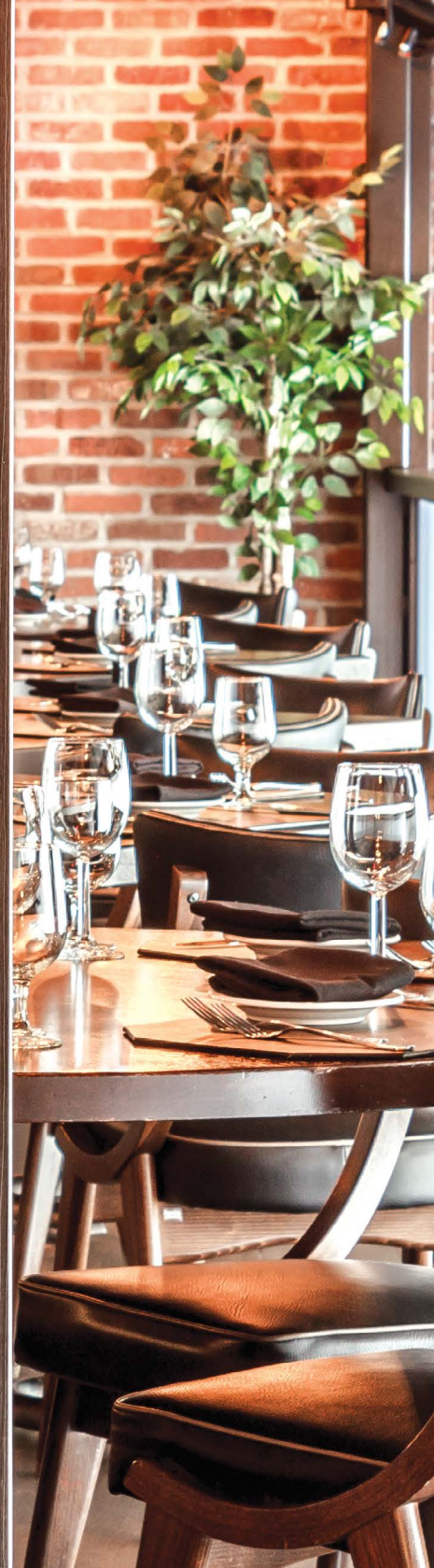

SYSTEM EXAMPLES

We offer a a broad variety of solutions - listed below are just a few of the many options available. Visit our website for a complete list of our standard offering and please contact us if you are looking for something more custom in nature.

Single Sliding

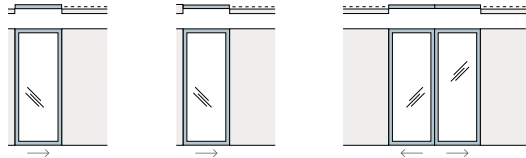

Sliding Bypass

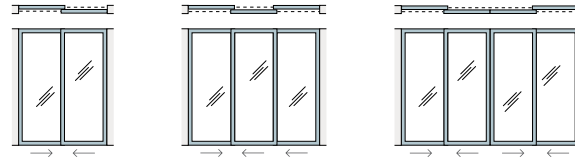

Sliding Wall

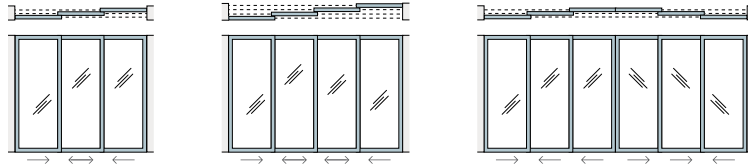

Pocket Door and Pocket Wall

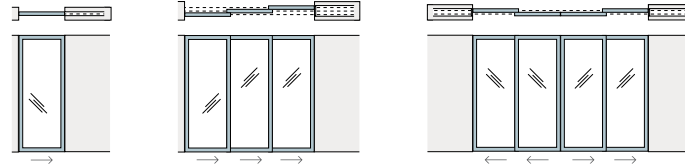

Sliding Wing Wall

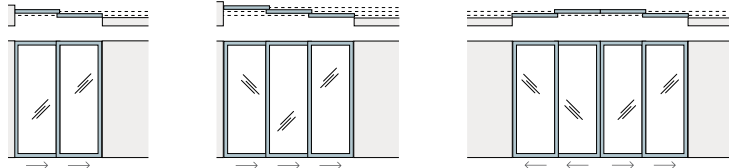

Stacking Wall

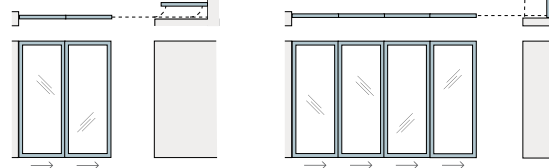

Swinging (Pivot) Folding End

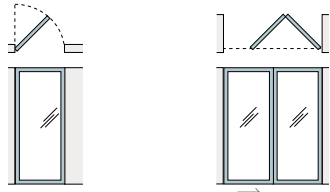

Demountable (Fixed) Panel with Slider

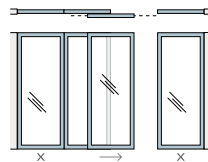

Stacking Wall with Pivot

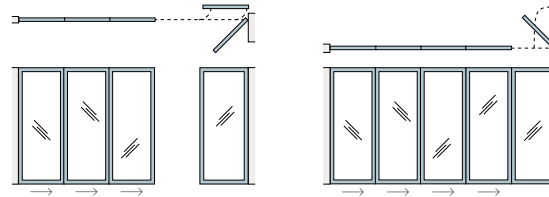



SINGLE SLIDING

Our single sliding doors are a great alternative to swinging doors, especially where narrow hallways restrict operation. Each door uses a small, floor mounted guide that is always concealed to align and stabilize the door where it overlaps an adjacent wall.

For wall-mounted situations (barn-door style mounting), we offer a sleek track that can be left exposed or be covered with an optional fascia. Larger panel overlaps with adjacent walls increase privacy and striking to a jamb or wall (one-side overlap) allows for more locking options.

Opening Width	Max Panel	Usage	Overlap	Clearance
24" or greater	5x10	High Frequency	1/2" to 3"	Approx 95%

SYSTEM EXAMPLES

1 Panel



1 Panel - OneSide Overlap



2 Panel - Symmetrical



Closed

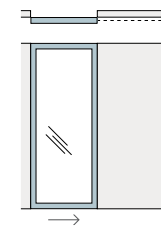

Open

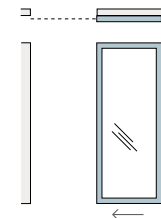

LOOKING FOR MORE?
VISIT RAYDOOR.COM FOR
FULL PRODUCT DETAILS

SLIDING BYPASS

One of our most versatile and cost-effective solutions, our bypassing systems can serve functions as diverse as simple closet doors all the way to large room dividers.

Bypassing systems use two or more doors but only two rows of tracks, which makes them perfect for larger openings where multiple rows of tracks are not possible. Each door has a small floor guide that is always concealed to help align and stabilize the panels. You can opt to have a panel be stationary by adding a flush bolt.

Opening Width	Max Panel	Usage	Overlap	Clearance
49" or greater	5x10	High Frequency	None	Varies

SYSTEM EXAMPLES

2 Panel



3 Panel



4 Panel



4 Panel - Symmetrical



5 Panel



Closed

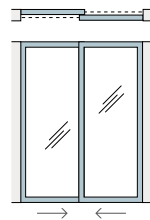

Open

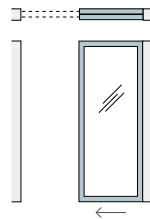



SLIDING WALL

Our sliding wall systems can divide large openings without unsightly floor track. Our patented Raydoor Guiding System links each panel, allowing a whole system to be operated by moving just the lead panel

To divide an even wider opening, you can pair two systems and have them operate symmetrically. This symmetrical setup is also useful for reducing the thickness of a header by allowing for fewer rows of tracks.



Opening Width	Max Panel	Usage	Overlap	Clearance
66" or wider*	5x10	Med-High Frequency	None	Greater Than 65%

SYSTEM EXAMPLES

3 Panel



4 Panel



5 Panel

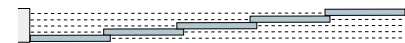

5 Panel - Symmetrical



6 Panel - Symmetrical



Closed

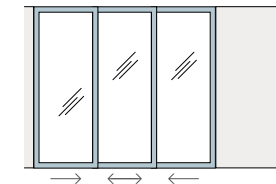

Open

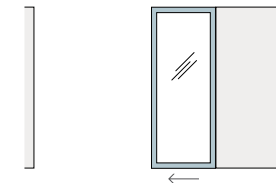

*wider opening possible with symmetrical

SLIDING WING WALL

Wing Wall systems are sliding walls, but mount and stack outside the opening, in front of an adjacent wall, leaving a larger usable opening. Wing Wall systems use two or more doors and can be configured in a symmetrical fashion (see bottom of page).

Our proprietary Raydoor Guiding System (RGS) allows the doors to telescope across the opening without the use of a floor track. Flush bolts are used to anchor the system at set intervals when needed but the system also uses a small floor guide which is always concealed by the trailing (last) panel.

Opening Width	Max Panel	Usage	Overlap	Clearance
45" or greater	5x10	Med-High Frequency	1/2 to 3"	Approx 98%

SYSTEM EXAMPLES

2 Panel



3 Panel



4 Panel



4 Panel - Symmetrical



6 Panel - Symmetrical

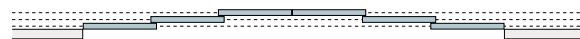

Closed

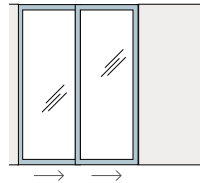
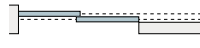

Open

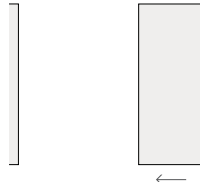
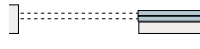



SLIDING POCKET

Our unique take on the sliding pocket door builds on its advantages of eliminating the need for clearance for a door swing and to completely disappear when not in use. To that we add the ability to fully extend a door from its pocket so that the complete stile and rail are visible.

The pocket door comes with an edge-mounted finger pull to retrieve it from the pocket. It also does not require a wider stile at the trailing end of the door for the stiles to look uniform when the door is extended (see technical detail below).

Opening Width	Max Panel	Usage	Overlap	Clearance
26" or greater	5x10 6x8	High Frequency	None	100%

SYSTEM EXAMPLES

1 Panel



2 Panel - Symmetrical

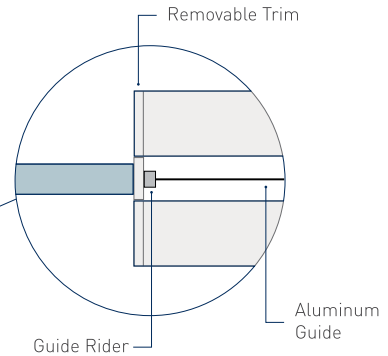

Technical Detail: Pocket Guide

To make sure that our panels perform reliably in pockets we use a continuous aluminum guide on the floor of the pocket. This prevents the door from possibly scraping on the inside of the pocket and is engaged by the guide rider even when the door is extended out of the pocket so the full frame is visible.

We recommend trim at the leading edge of the pocket that narrows the gap for a cleaner look.

SLIDING POCKET WALL

Pocket walls can move completely out of an opening and like single pocket doors, they utilize a "pocket concealment panel" to close off the pocket entry when doors are extended. This eliminates what would otherwise be a large gap, making it more seamless but also making it child and pet friendly.

Sliding pocket walls are always connected to the pocket floor guide. By linking one panel to the next through the patented Raydoor Guiding System and having the trailing panel always couple to the guide that exists on the floor of the pocket, the entire system stays stable.

Opening Width	Max Panel	Usage	Overlap	Clearance
45" or greater	5x10	Med-High Frequency	None	100%

SYSTEM EXAMPLES

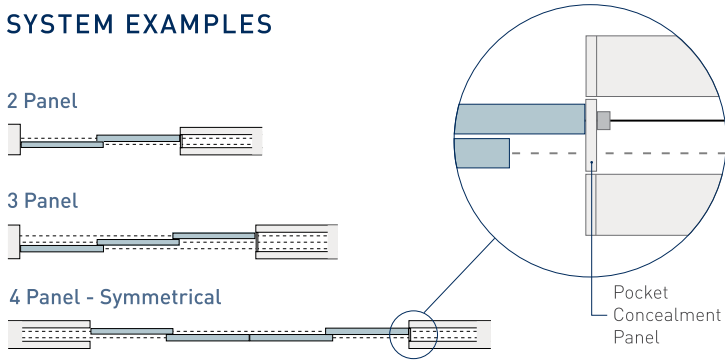

Technical Detail: Concealment Panel

Our pocket doors have unique components to create a more visually appealing result. To ensure that when a door in pocket lines up with the adjacent wall, we use a guide on the floor of the pocket in conjunction with a stop plate on the door so that there is no guesswork or fine-tuning of track stops necessary.

In addition, we use a pocket concealment panel that helps to close the gap of the pocket opening when the door is extended for a seamless look.





SLIDING STACKING PERPENDICULAR

This system features the ability to stack and store numerous panels perpendicular to the track run. The system can be specified to turn a corner and can incorporate a swinging door for egress concerns or frequent usage. Thin tracking allows for narrow headers where the doors slide across an opening.

This popular meeting room option allows users to have the best of both worlds, a wall that can include all day ingress/egress and then easily move to create a large open space.

Opening Width	Max Panel	Usage	Overlap	Clearance
44" or greater	4 x 10	* Med Frequency	up to 3"	Approx 95%

SYSTEM EXAMPLES

3 Panel

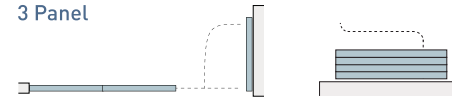

4 Panel - With Pivot

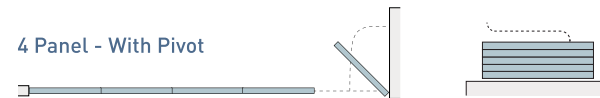

Closed

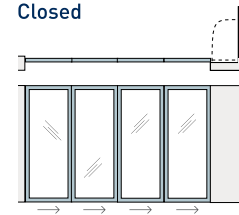

Open

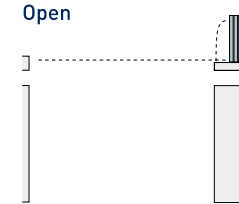

*high frequency with swinging egress doors

SLIDING STACKING PARALLEL

One of our most versatile options and popular in hospitality applications, our Sliding Stacking Parallel system can store numerous panels parallel to the track run. Panels slide straight and can also be specified to turn a corner.

As with our perpendicular system, it can be specified with a swinging pivot door for everyday ingress and egress and only requires a narrow header where the doors slide.

Opening Width	Max Panel	Usage	Overlap	Clearance
44" or greater	4 x 10	* Med Frequency	up to 3"	Approx 95%

SYSTEM EXAMPLES

3 Panel



4 Panel - With Pivot

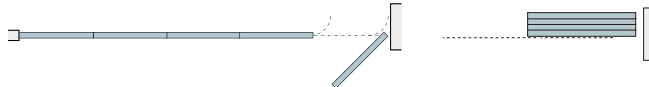

Closed

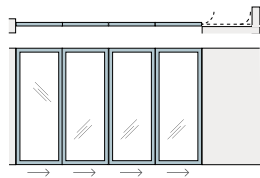

Open

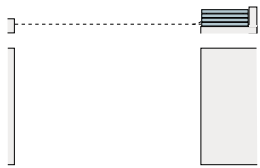

*high frequency with swinging egress doors





FOLDING END

Great for closets and room dividers, our Folding End systems are a premium option and come with spring-loaded mechanisms to hold doors flat (see photo below). They can be arranged as a single pair or two pairs symmetrically positioned on either side of an opening. We can also provide a swinging egress door to work opposite a folding pair.

Folding End systems are also provided path flush bolts and face mounted rectangular pulls. They are a more traditional option but with a few unique touches by Raydoor.

Opening Width	Max Panel	Usage	Overlap	Clearance
41" - 145"	3x10	*Low-Med Frequency	None	Approx 92%

SYSTEM EXAMPLES

2 Panel

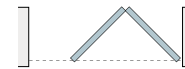

4 Panel - Symmetrical



Technical Detail: Spring Loaded Catch

A common issue with folding doors is their tendency to creep back towards a folded position after being extended. We solve this with a spring-loaded mechanism at the top that holds the extended doors in line with the overhead track.



* medium to high frequency with swinging egress door

DEMOUNTABLE (FIXED)

Often used in conjunction with one of our other systems, Demountable panels are very versatile because they can be used in a series to create a wall, room or as screens of any length for added privacy to a particular area.

Easy to install with simple connections and adjustments, they offer the ability to have stationary panels that match your operable ones. Or have them stand alone and allow light to filter through just as it does on our operable walls.

Opening Width	Max Panel	Usage	Overlap	Clearance
12" or greater	5'x10'	N/A	N/A	N/A

SYSTEM EXAMPLES

2 Panel



3 Panel with Single Slider

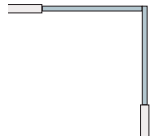

Usage Suggestion: Office Wall

Combining our Demountable panels with a sliding panel can create an entire entry wall of an office with simple to install hardware. This avoids the time and mess that would come with a traditional build-out and makes moving or reconfiguring a cinch. They can even be arranged to make multiple sides of a room, creating a private office for less than the price of a cubicle.





SWINGING (PIVOT)

Unlike traditional swing doors, our pivot doors utilize top and bottom pivots instead of hinges. This partially conceals the hardware, giving the illusion of a floating panel. It also allows the possibility of eliminating wood stops at the sides and top for a cleaner jamb and in a scenario where there is no header, an uninterrupted ceiling from one room to the next.

Pivot doors come with rectangular pulls and a ball catch and offer a different take on what is the most common way to address an opening.

Opening Width	Max Panel	Usage	Overlap	Clearance
24" or greater	4x10	Med Frequency	None	Approx 92%

SYSTEM EXAMPLES

1 Panel

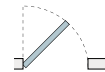

2 Panel - Symmetrical

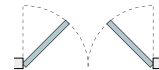

Upgrade Options

Pivot doors can be ordered with a bar pull instead to suit a different aesthetic or just ADA needs. If you're looking for a cleaner opening without wood stops, you can upgrade to a roller catch to act as a spring-loaded stop.

And if privacy is a concern, try specifying a pivot door with our straight-bolt lock or floor strike lock.





DESIGN OPTIONS

FINISHES & HARDWARE

Raydoor began as a highly customizable product and we continue that flexibility with new offerings that allow you to personalize the appearance and add function to your Raydoor system.

A wide range of finishes are available to choose from, and if you have something more specific in mind we also offer custom-matching for veneer frame colors. On top of that we have several insert choices and hardware upgrades you can select... or suggest your own. Our staff will gladly consult on design considerations and help guide you to find a solution that suits your space and style.

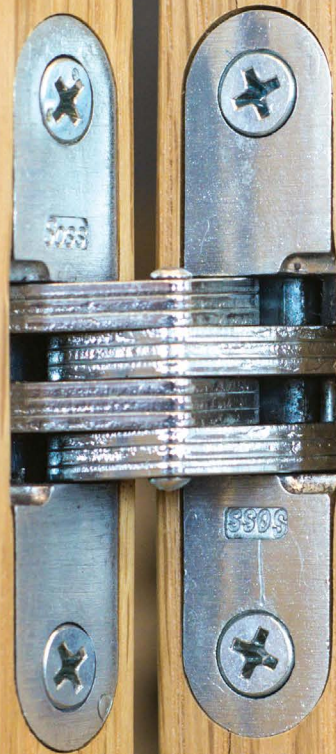

FRAMES & INSERTS

Designed to complement any design aesthetic, our collection of frame finishes are offered in laminate and wood veneer. Color matching is available with wood veneer frames. All of our options are more than durable enough for any interior setting. Sustainably harvested wood in our laminate frames with no added urea formaldehyde. Veneer frames CARB II material used.

Our inserts can be either acrylic, laminate or wood veneer and we offer a wide selection of standard and custom options. Completely transparent, opaque and several in-between for any level of privacy desired.

Laminate



Sierra White

Brushed Steel

Black Oak

Real Wood Veneer



Coffee Wood

Rift Oak

Natural Teak

Walnut

Painted Black

Milano

Glazing



Opal(100% recycled content)



Cloud (100% recycled content)



Transparent

Custom



Many options avl.

Veneer

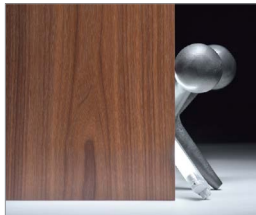

Many options avl.

Laminate

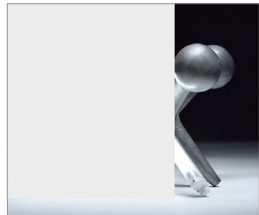

Many options avl.

PATTERNS & HARDWARE

Patterns are a great way to customize any Raydoor panel. Either select from standard patterns or create a custom one of your own design. Patterns can be purely aesthetic in their purpose, they can divide between different inserts, or they can mimic other things in your space like a line of shelves to make the panels more cohesive with the design of a room.

Our systems come with all necessary hardware but we offer a variety of locks, pulls and ADA upgrades to help meet your specific build requirements. Part of our offering is designed with operable walls in mind but we also have unique items like our Jamb Lock.

Patterns

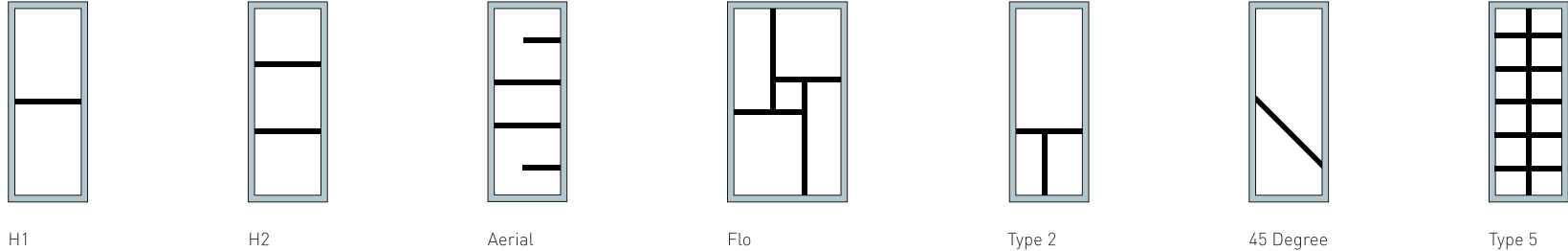

Pulls



Locks



*Available in brushed metal or black

INTRODUCING **GLASS**

AESTHETICS & PERFORMANCE

Our patented TwinFrame® panel has utilized acrylic & PETG glazing for its lightweight strength, optical clarity, and impact resistance. Now, for those projects where the unique aesthetic and performance properties of glass are required or preferred, we're offering tempered RAYDOOR Glass™.

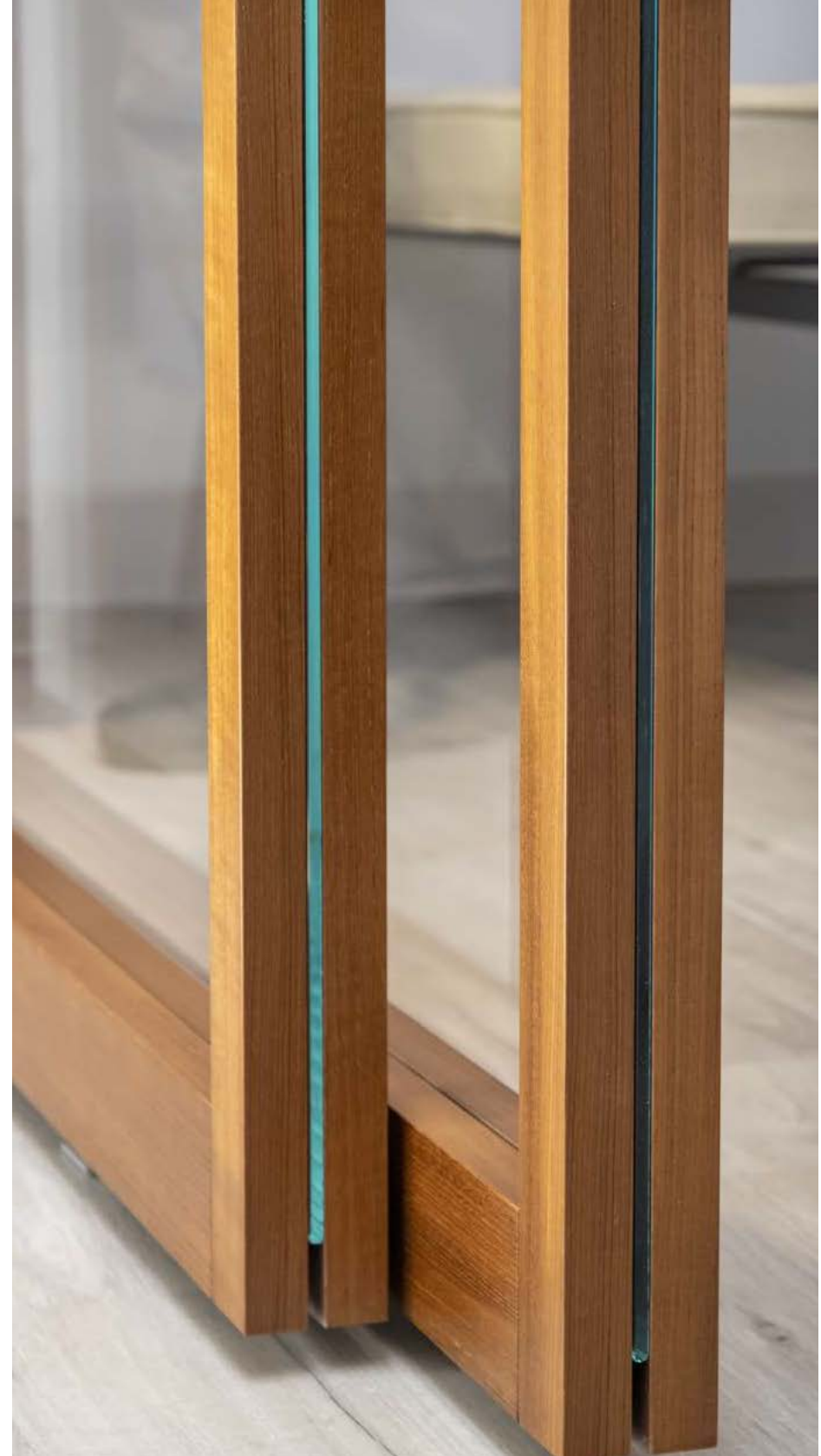

GLASS FRAME OPTIONS

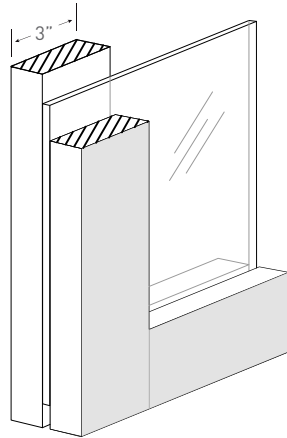

Standard

3" stile, 3" rail is the minimum standard thickness frame profile available for MAXIMUM compatibility with the broadest range of glazing inserts, system configurations, hardware options and panel sizes. Larger stiles and rails are available.

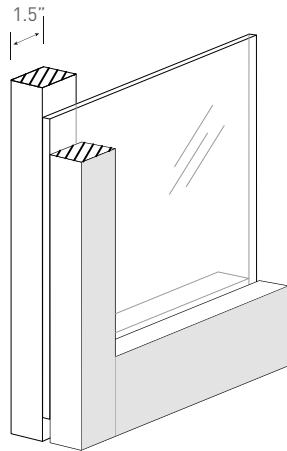

Low Profile

1.5" stile, 3" rail is only available with our glass offering and a more LIMITED range of system configurations, hardware options and panel sizes. Larger rails are also available.





Rift White Oak & Acid Etched

Cherry & Low Iron Clear

Painted Black & Low Iron Clear



Teak & Tempered Low Iron Clear

HEADER & MOUNTING

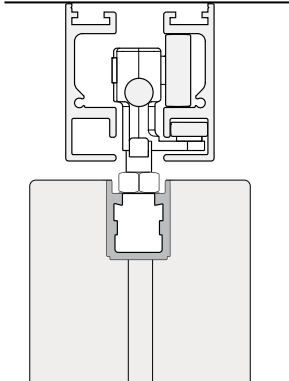

Sliding Stacking

Our sliding stacking track comes in clear anodized aluminum. Silent running nylon wheels on roller bearings are mounted to channels that are factory mortised into the top of the door, reducing the distance between the top of the door and the bottom of the track.

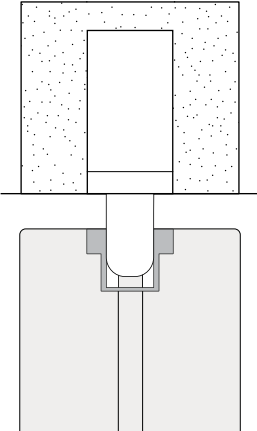

Swinging (Pivoting)

Pivot hardware leaves no exposed components and provides the greatest range of motion.

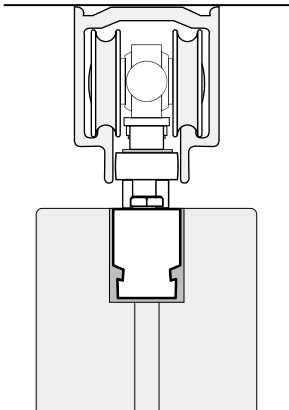

Folding

Our standard folding track comes in clear anodized aluminum. Nylon wheels are mounted to channels that are factory mortised into the top of the door.

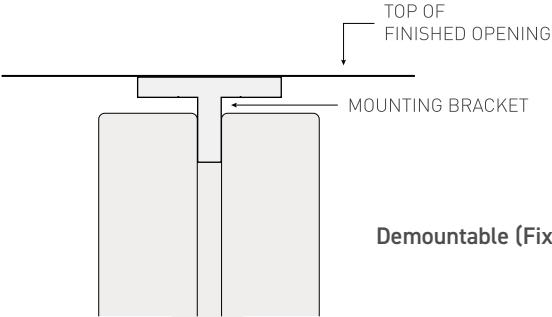

Demountable (Fixed)



LOOKING FOR MORE?
VISIT RAYDOOR.COM FOR
MORE TECHNICAL DRAWINGS

Soft Close Sliding Track

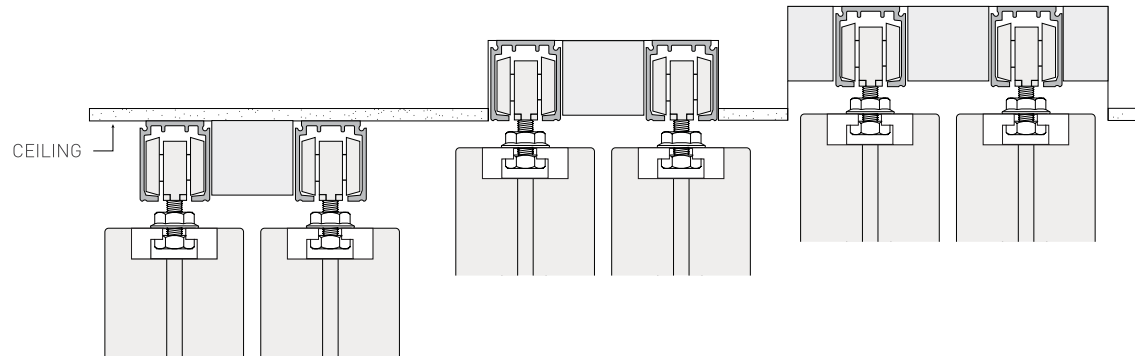

Folding track

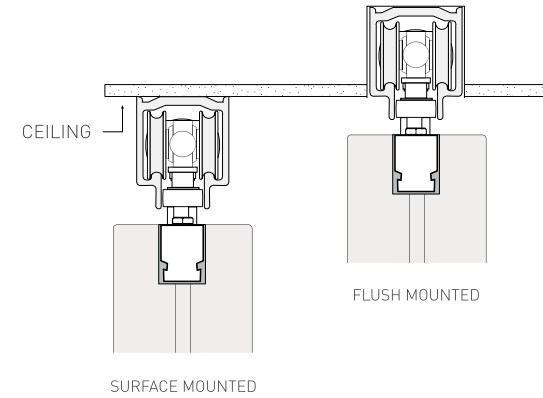

Wall mount options

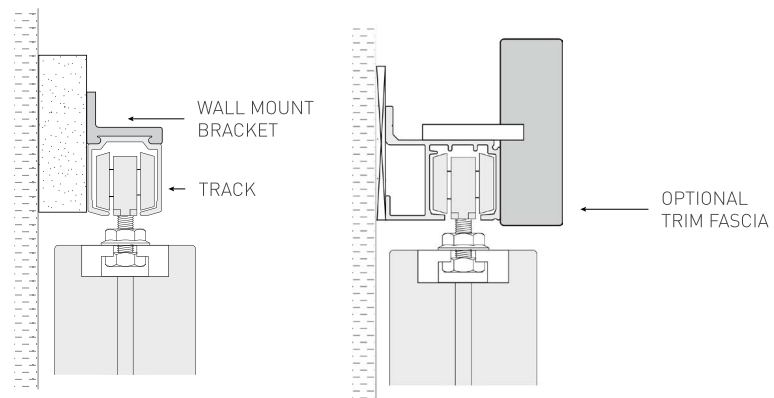

Sliding stacking track

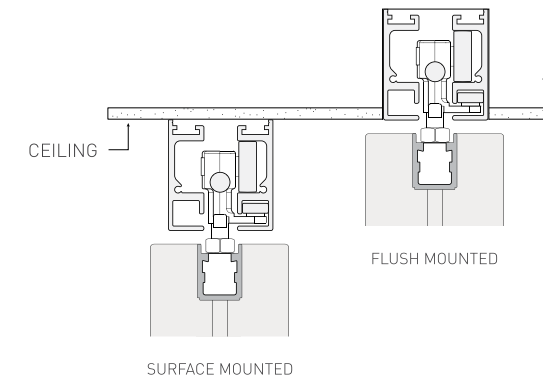

FLOOR DETAILS

Single Sliding

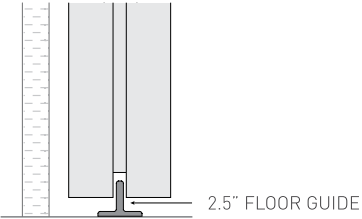

Sliding Bypass

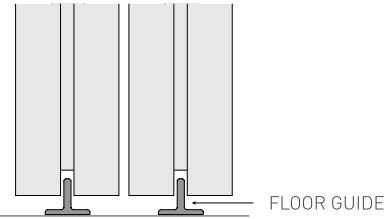

Sliding Stacking

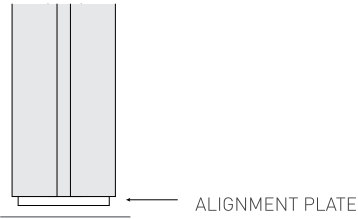

Sliding Wall

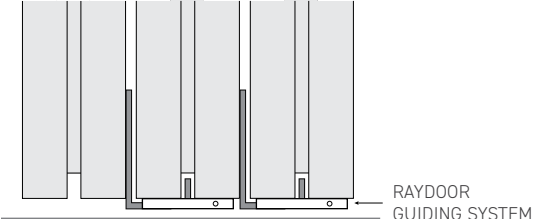

Sliding Wing Wall



Folding End

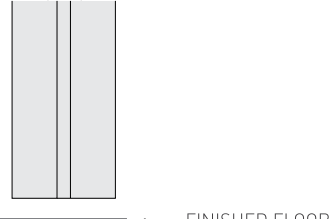

Sliding Pocket

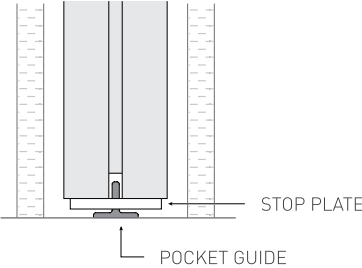

Sliding Pocket Wall

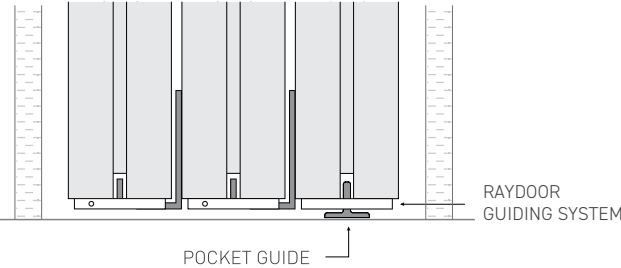

Demountable (Fixed)

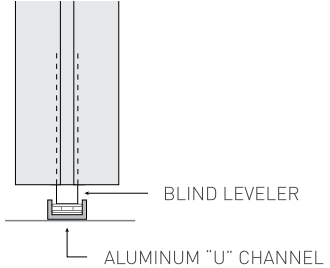



For our current list of product options please visit: raydoor.com

Follow us on social media for our latest updates.



www.raydoor.com
[212] 421-0641

SHOWROOM:
134 W. 29th St., Ste. 909
New York, NY 10001

© RAYDOOR 2025

